



OP-MP+832L1SD-20

10.3Gb/s SFP+ BIDI Transceiver

■ Product Features

- ✓ Single LC connector
- ✓ Hot-pluggable SFP footprint
- ✓ Uncooled DFB laser
- ✓ RoHS compliant and Lead Free
- ✓ Distance up to 20Km on 9/125um SMF
- ✓ Metal enclosure for lower EMI
- ✓ Power dissipation <1.0W (0~70°C)
<1.2W(-40~85°C)
- ✓ Commercial and industrial operating temperature optional
- ✓ SFP MSA SFF-8472 SFF-8431 SFF-8432 Compliant

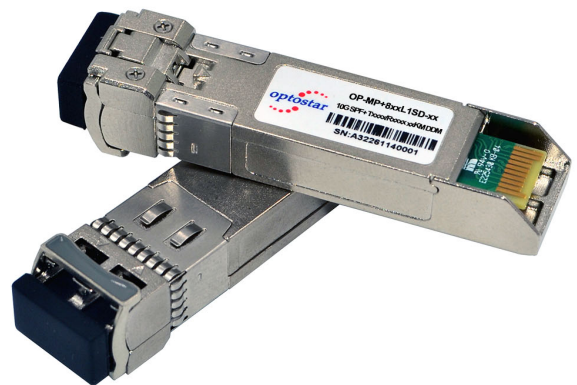

■ Applications

- ✓ 10GBASE-LR/LW
- ✓ 10G Fibre Channel

■ General

OPTOSTAR OP-MP+832L1SD-20 Small Form Factor Pluggable (SFP+) transceivers are compatible with SFF-8431, SFF-8432 and support 10G Ethernet LR and 10G Fibre Channel. It is designed for use in 10G-Gigabit multi-rate links up to 20km of G.652. Digital diagnostics functions are available via a 2-wire serial interface, as specified in SFF-8472.

■ Product Selection

Part Number	Wavelength	Operating Case temperature
OP-MP+823L1SD-20	Tx-1270 / Rx-1330	Commercial
OP-MP+832L1SD-20	Tx-1330 / Rx-1270	Commercial
OP-MP+823L2SD-20	Tx-1270 / Rx-1330	Industrial
OP-MP+832L2SD-20	Tx-1330 / Rx-1270	Industrial

■ Regulatory Compliance

- ESD to the Electrical PINs: compatible with MIL-STD-883 Method 3015
- ESD to the Duplex LC Receptacle: compatible with IEC 61000-4-2
- Immunity compatible with IEC 61000-4-3
- EMI compatible with FCC Part 15 Class B EN55022 Class B (CISPR 22B) VCCI Class B
- Laser Eye Safety compatible with FDA 21CFR 1040.10 and 1040.11 EN60950, EN (IEC) 60825-1,2
- RoHS compliant with 2002/95/EC 4.1&4.2 2005/747/EC

■ Pin Descriptions

Pin	Symbol	Name/Description	Ref.
1	VeeT	Transmitter Ground (Common with Receiver Ground)	1
2	TX Fault	Transmitter Fault. LVTTTL-O	2
3	TX Disable	Transmitter Disable. Laser output disabled on high or open. LVTTTL-I	3
4	SDA	2-Wire Serial Interface Data Line (Same as MOD-DEF2 in INF-8074i). LVTTTL-I/O	2
5	SCL	2-Wire Serial Interface Data Line (Same as MOD-DEF2 in INF-8074i). LVTTTL-I	2
6	Mod_ABS	Module Absent, Connect to VeeT or VeeR in Module.	2
7	RS0	Rate Select 0, optionally controls SFP+ module receiver LVTTTL-I	4
8	LOS	Loss of Signal indication. Logic 0 indicates normal operation. LVTTTL-O	5
9	RS1	Rate Select 1, optionally controls SFP+ module transmitter. LVTTTL-I	4
10	VeeR	Receiver Ground (Common with Transmitter Ground)	1
11	VeeR	Receiver Ground (Common with Transmitter Ground)	1
12	RD-	Receiver Inverted DATA out. AC Coupled. CML-O	
13	RD+	Receiver Non-inverted DATA out. AC Coupled. CML-O	
14	VeeR	Receiver Ground (Common with Transmitter Ground)	1

15	VccR	Receiver Power Supply	6
16	VccT	Transmitter Power Supply	6
17	VeeT	Transmitter Ground (Common with Receiver Ground)	1
18	TD+	Transmitter Non-Inverted DATA in. AC Coupled. CML- I	
19	TD-	Transmitter Inverted DATA in. AC Coupled. CML- I	
20	VeeT	Transmitter Ground (Common with Receiver Ground)	1

Notes:

1. Circuit ground is internally isolated from chassis ground.
2. TX Fault is an open collector/drain output .which should be pulled up with a 4.7K – 10K Ohms resistor on the host board if intended for use .Pull up voltage should be between 2.0V to Vcc+0.3V.A high output indicates a transmitter fault caused by either the tx bias current or the tx output power exceeding the preset alarm thresholds .A low output indicates normal operation .In the low state, the output is pulled to <0.8V.
3. Laser output disabled on TX Disable >2.0V or open, enabled on TX Disable<0.8V.
4. Internally pulled down per SFF-8431 Rev4.1.
5. LOS is open collector output. Should be pulled up with 4.7k – 10kohms on host board to a voltage between 2.0V and 3.6V. Logic 0 indicates normal operation; logic 1 indicates loss of signal.
6. Internally connected

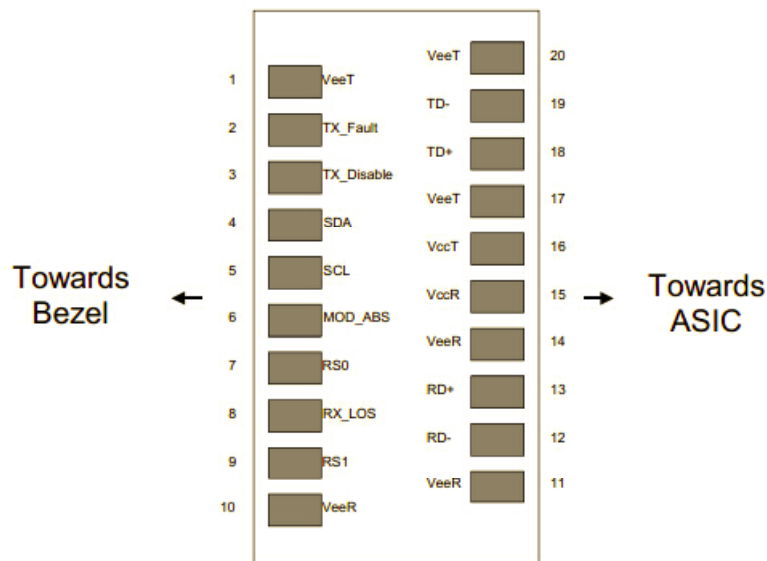

Pin-out of Connector Block on Host Board

Recommend Circuit Schematic

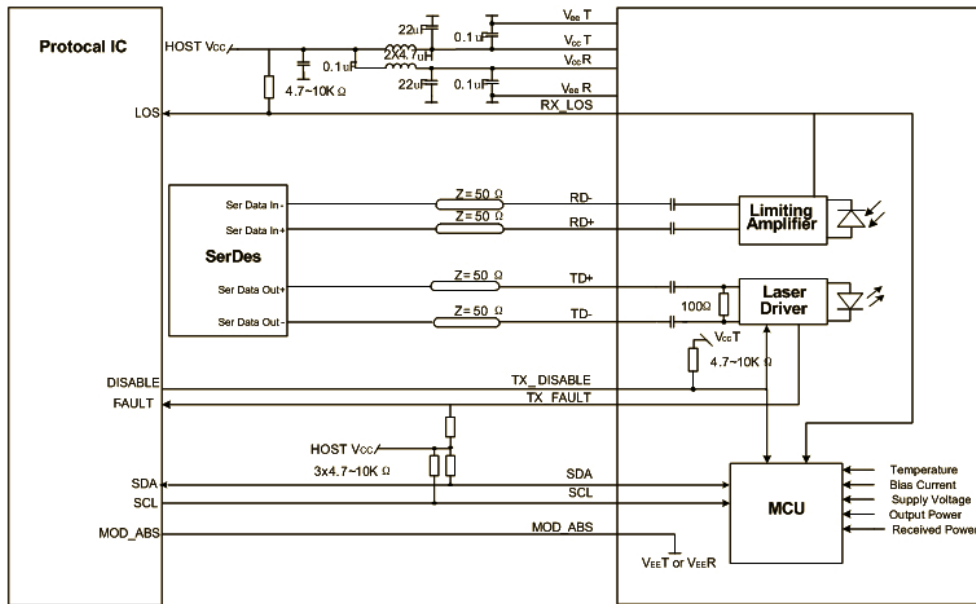

Absolute Maximum Ratings

Parameter	Symbol	Min	Typ	Max	Unit	Ref.
Maximum Supply Voltage	Vcc	-0.5		+4.0	V	
Storage Temperature	TS	-40		+85	°C	
Operating Humidity	RH	0		85	%	

Recommended Operating Conditions

Parameter	Symbol	Min	Typ	Max	Unit	Ref.
Power Supply Voltage	Vcc	3.13	3.30	3.47	V	
Power Supply Current	Icc			300	mA	Commercial
	Icc			350	mA	Industrial
Case Operating Temperature	Tc	0		+70	°C	Commercial
	Tl	-40		+85		Industrial
Data Rate(Gigabit Ethernet)	BR		10.3		Gbps	
9/125um G.652 SMF	Lmax			20	km	

Electrical Characteristics (TOP=25°C, Vcc=3.3Volts)

Parameter	Symbol	Min	Typ	Max	Unit	Ref.
Transmitter						
Input differential impedance	Rin	80	100	120	Ω	1

Differential data input swing	Vin, pp	120		850	mV	
TX Disable-High		Vcc – 0.8		Vcc	V	
TX Disable-Low		Vee		Vee+ 0.8	V	
TX Fault-High		Vcc-0.8		Vcc	V	
TX Fault-Low		Vee		Vee+0.8	V	
Receiver						
Single ended data output swing	Vout, pp	300		850	mV	2
Data output rise time	Tr	30			ps	3
Data output fall time	Tf	30			ps	3
LOS-High		Vcc – 0.8		Vcc	V	
LOS-Low		Vee		Vee+0.8	V	

Notes:

1. AC coupled.
2. Into 100 ohm differential termination.
3. 20 – 80 %

Optical Characteristics (TOP=25°C, Vcc=3.3 Volts)

Parameter	Symbol	Min	Typ	Max	Unit	Ref.
Transmitter						
Output Opt. Power	PO	-2		+3	dBm	
Optical Wavelength	λ	1260	1270	1280	nm	
		1320	1330	1340	nm	
Side-Mode Suppression Ratio	SMSR	30			dB	
Spectral Width(-20dB)	$\Delta\lambda$			1	nm	
Optical Extinction Ratio	ER	3.5			dB	
Receiver						
RX Sensitivity @10.3Gb/s	SENS1			-13	dBm	1,2
Receiver Overload		0.5			dBm	
Optical Center Wavelength	λ_C	1320	1330	1340	nm	
		1260	1270	1280	nm	

LOS De-Assert	LOSD			-15	dBm	
LOS Assert	LOSA	-30			dBm	
LOS Hysteresis		0.5		5	dB	

Notes:

1. Measured with conformance signals defined in FC-PI-2 Rev. 10.0 specifications.
2. Measured with PRBS $2^{31}-1$ at 10^{-12} BER.

■ Mechanical Specifications

OPTOSTAR's Small Form Factor Pluggable(SFP+) transceivers are compatible with the dimensions defined by the SFP Multi-Sourcing Agreement (MSA).

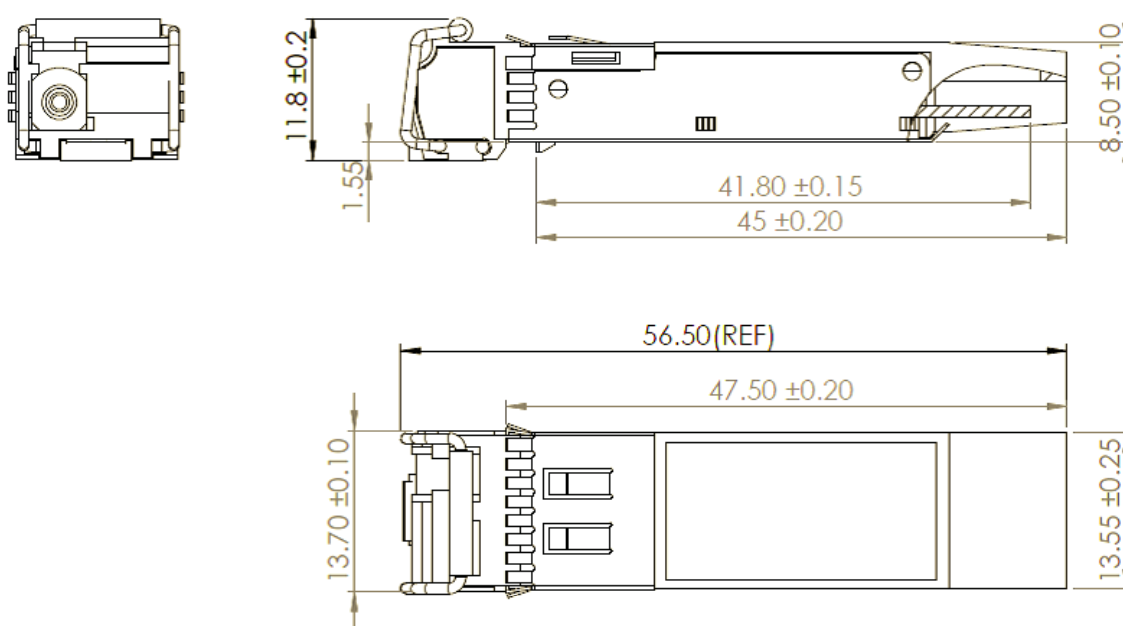

■ EEPROM Information

EEPROM memory map specific data field description is as below:

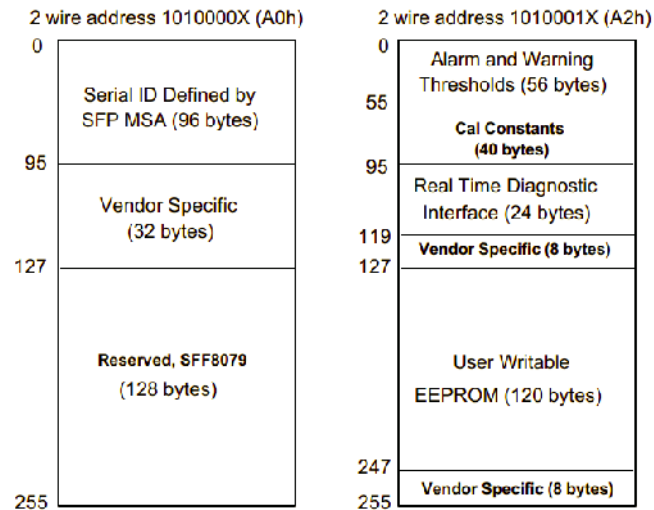

■ Digital Diagnostic Monitoring Interface

Five transceiver parameter values are monitored. The following table defines the monitored parameter's accuracy.

Parameter	Range	Accuracy	Calibration
Temperature	0 to +70°C (C)	±3°C	Internal
	-40 to +85°C (I)		
Voltage	2.97 to 3.63V	±3%	Internal
Bias Current	0 to 100mA	±10%	Internal
TX Power	-2 to +3dBm	±3dB	Internal
RX Power	-13 to 0.5dBm	±3dB	Internal

■ For More Information

Shenzhen Optostar Optoelectronics Co., Ltd

Address:A-14,Haide Building,Haide Second Road Nanshan District,Shenzhen,P.R.China

Tel: +86-755-26400198 +86-755-26400288

Fax: +86-755-26411001

Email: info@optostar.com.cn

Skype:ouyangroya

Web: www.optostar.com.cn